

Second Focal Plane RETICLES

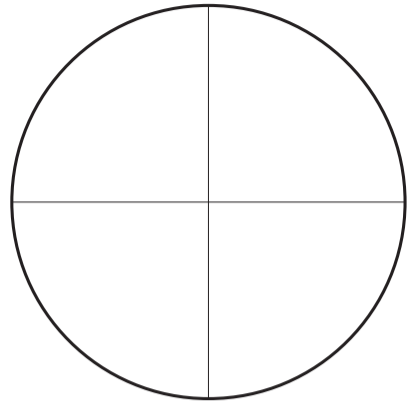

Cross Hair

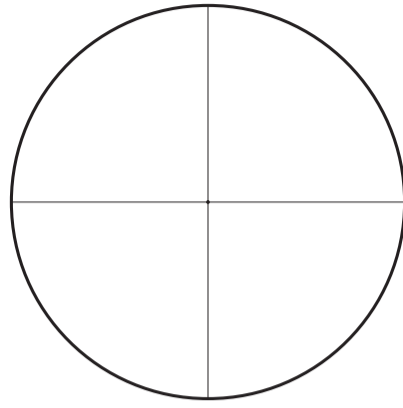

Dot

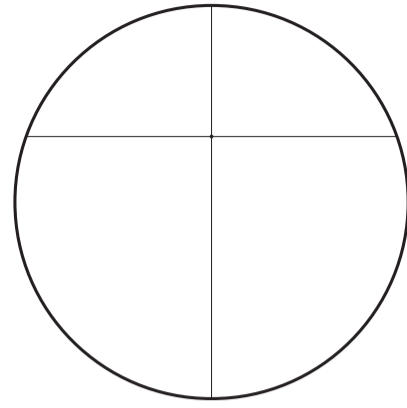

LR

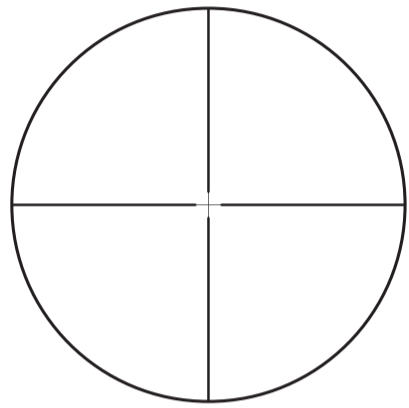

Di-plex

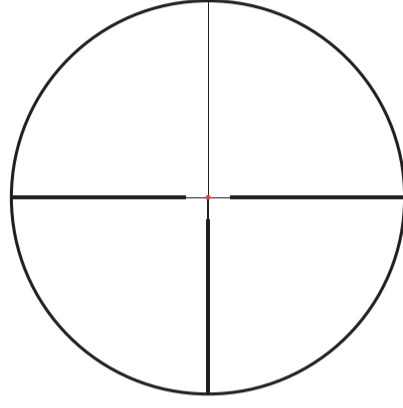

FD-1

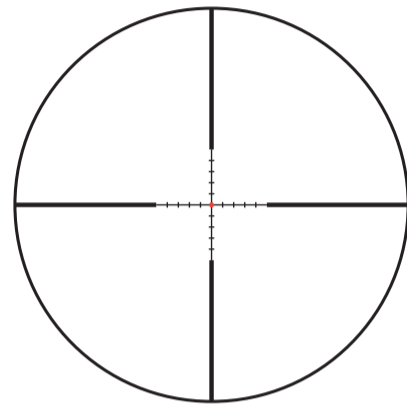

FD-2

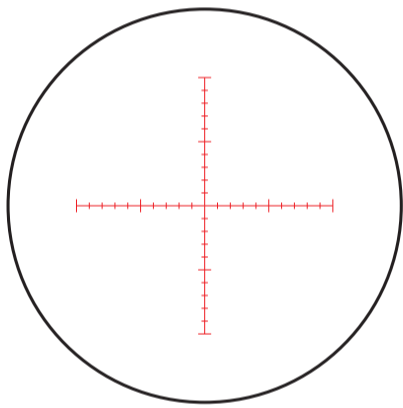

MTR-1

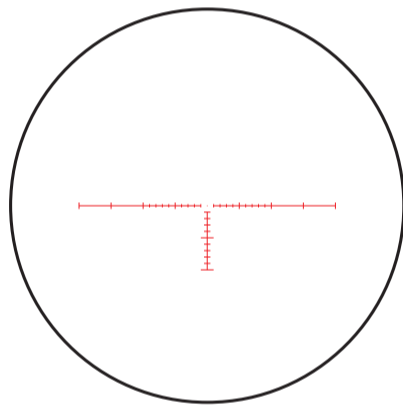

MTR-2

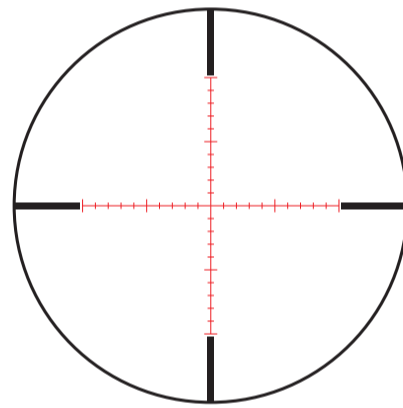

MTR-3

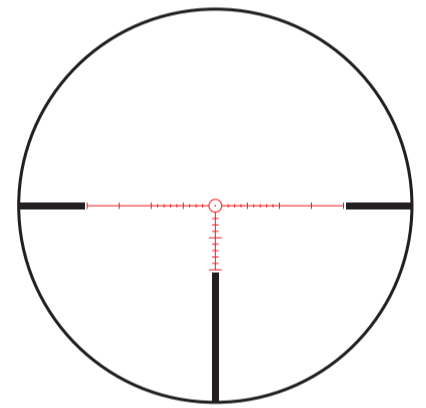

MTR-4

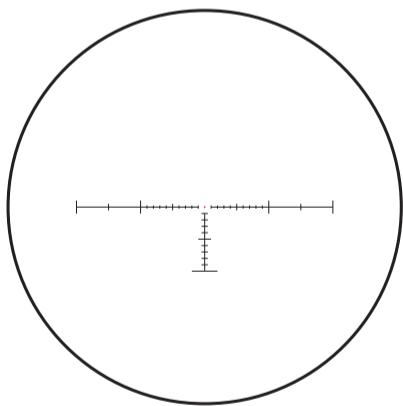

MTR-5

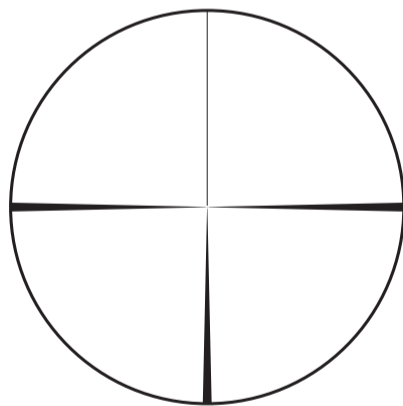

MTR-D2

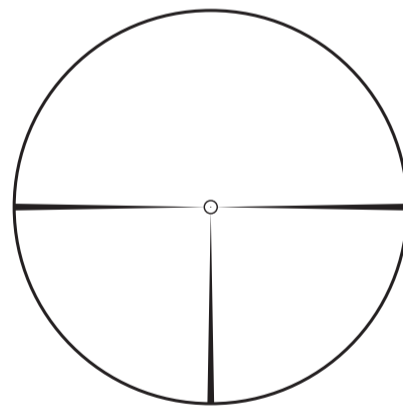

MTR-D3 (Non-Illumi)

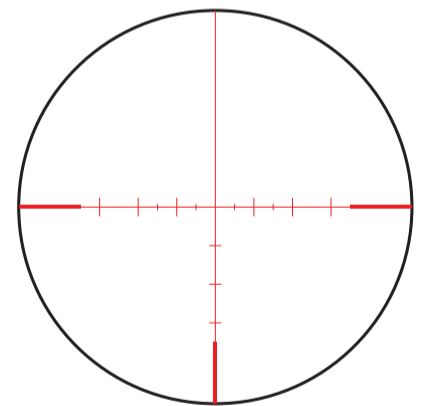

MTR-FT

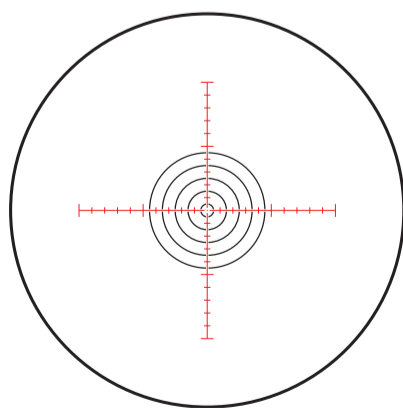

MTR-RTM

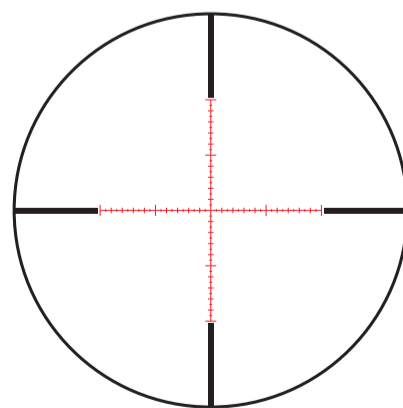

MML

Second Focal Plane RETICLES

8-80x56 MAJESTA

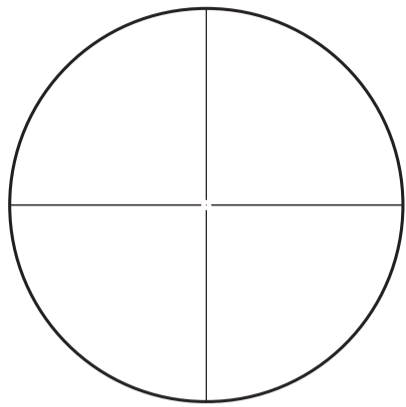

W-Dot

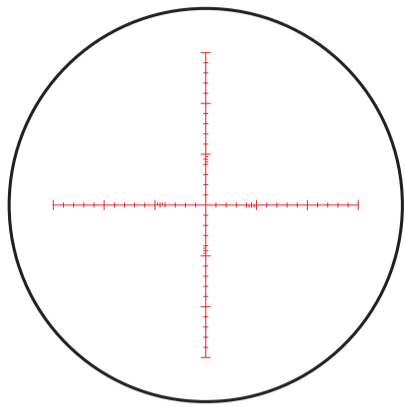

MTR-W0

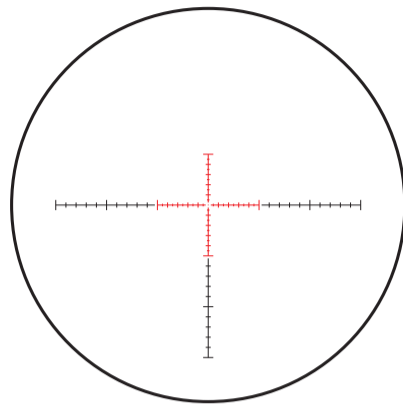

MTR-W1

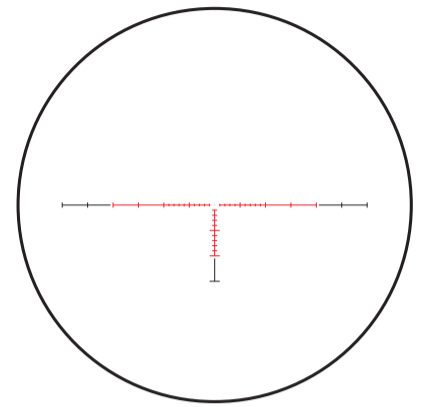

MTR-W2

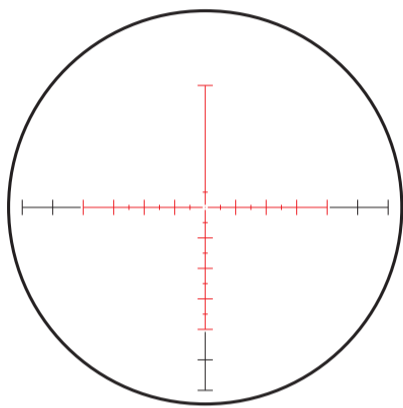

MTR-WFT

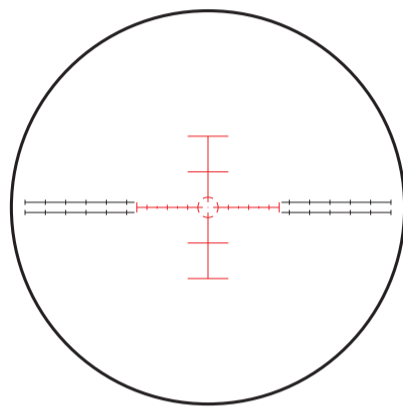

MTR-WFD

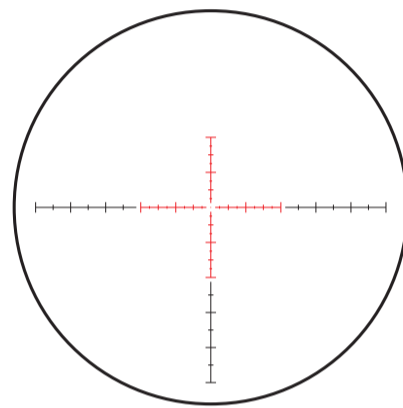

MML-W1

SFP Available List

48x52 & 40-60x52

Cross Hair , Dot (1/8moa, 3/32moa, 1/16moa) , LR

1-4x24

FD-1, FD-2

1-4.5x24

MTR-5, MTR-D2, MTR-D3

1.5-15x42

MML, FD-1, FD-2

MTR-3, MTR-4, MTR-5

1-10x24

Di-Plex

MTR-1, MTR-2, MTR-3, MTR-4, MTR-5

MML, FD-1, FD-2

2.5-25x42 & 2.5-25x52

Di-Plex, MTR-1, MTR-2, MTR-3, MTR-4,

MTR-5, MTR-FT, MTR-RTM

MML, FD-1, FD-2

10-60x52, 5-50x56, 8-80x56, 10-60x56

Cross Hair, Dot (1/8moa, 3/32moa, 1/16moa), Di-Plex

MTR-1, MTR-2, MTR-3, MTR-4, MTR-5, MTR-FT, MTR-RTM



First Focal Plane RETICLES

1-8x24 & 1-8x24 Shorty

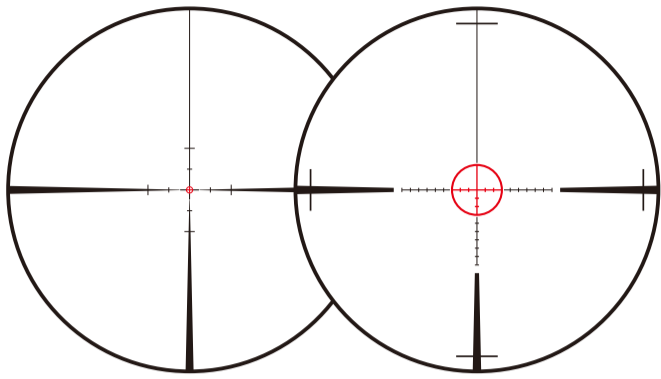

FMC-1

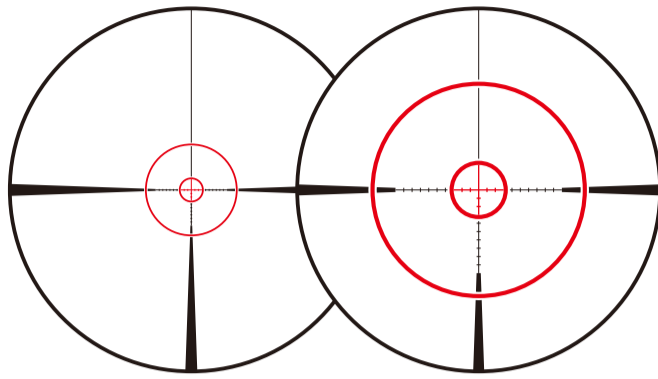

FMC-2

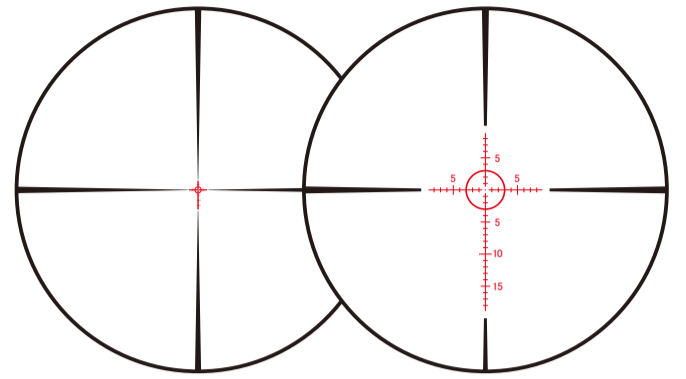

FMC-3

1-10x24 Shorty

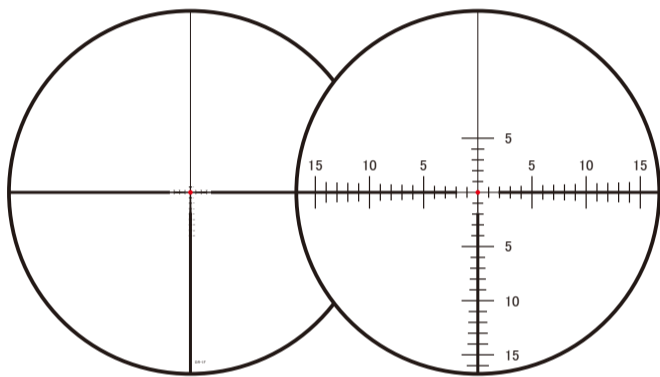

DR-1F (Dual)

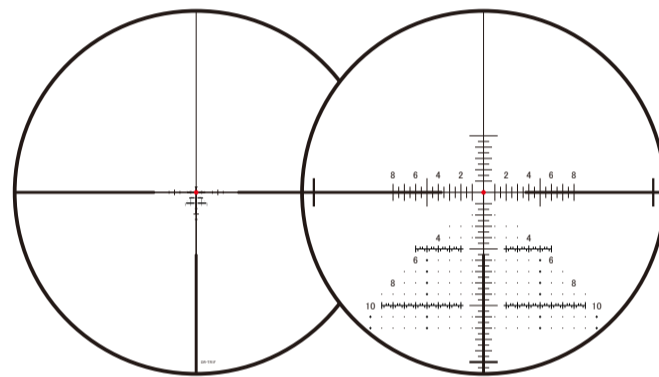

DR-TR1F (Dual)

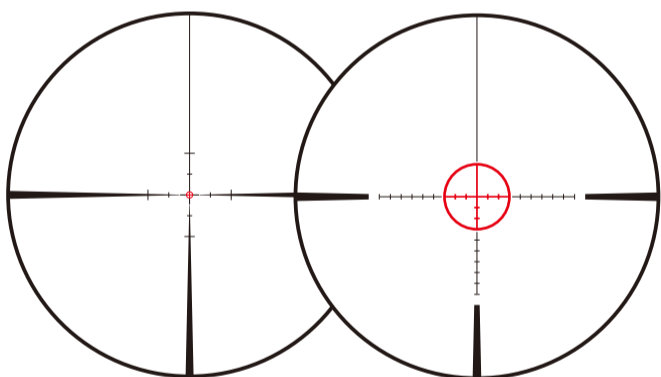

FMC-1

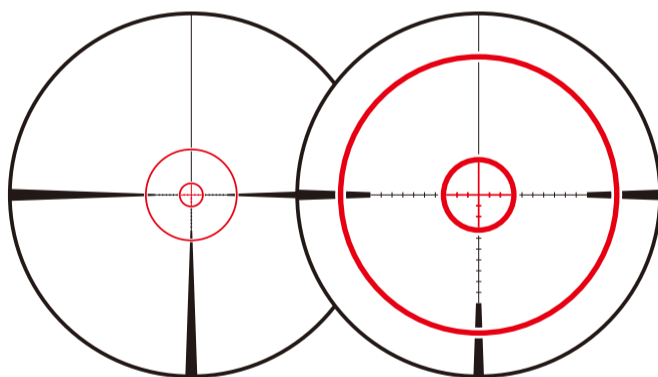

FMC-2

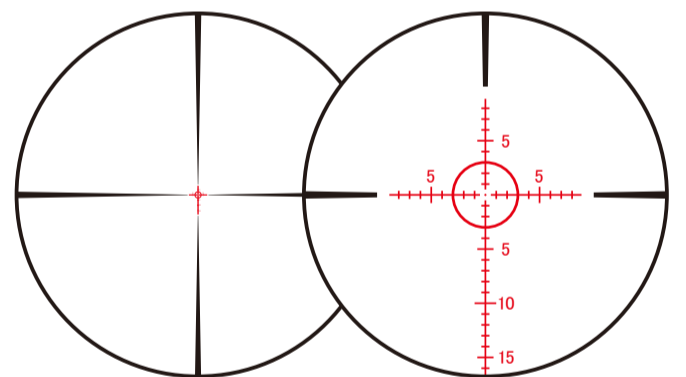

FMC-3

1.5-15x42

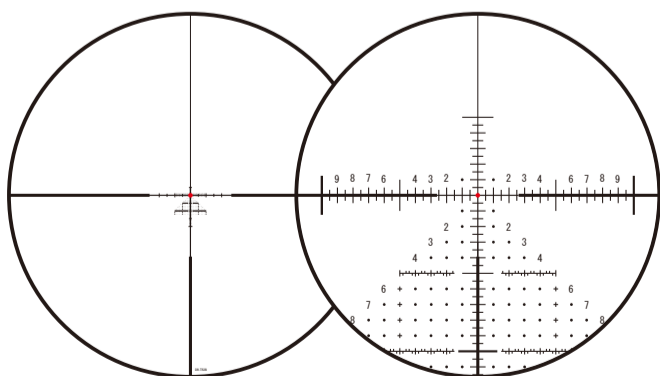

DR-TR2B (Dual)

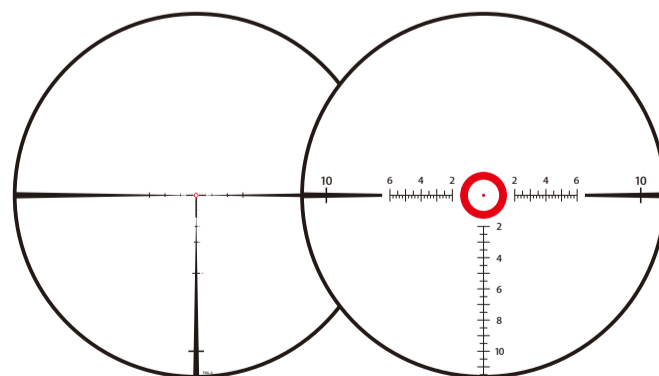

FML-4

First Focal Plane RETICLES

Images are at the lowest power of the scope and at 20x

3-24x42 & 3-24x52

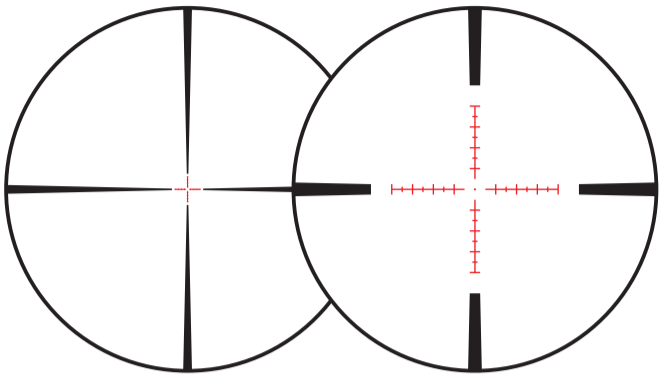

FML

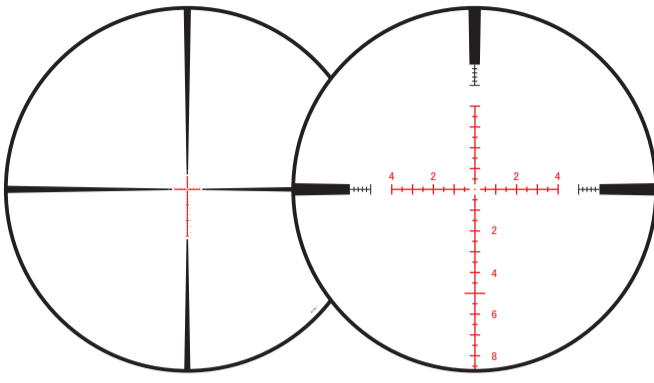

FML-1

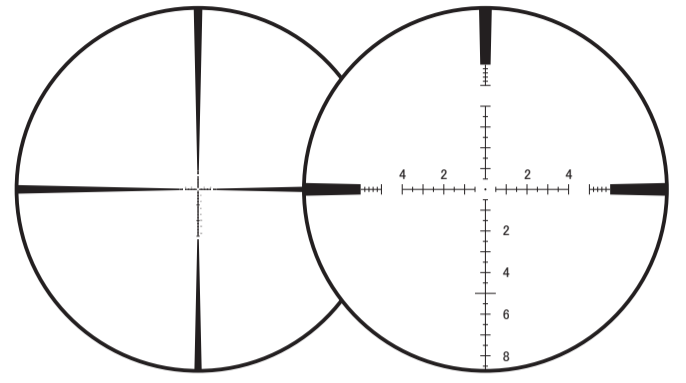

FML-1 (Non-Illumi)

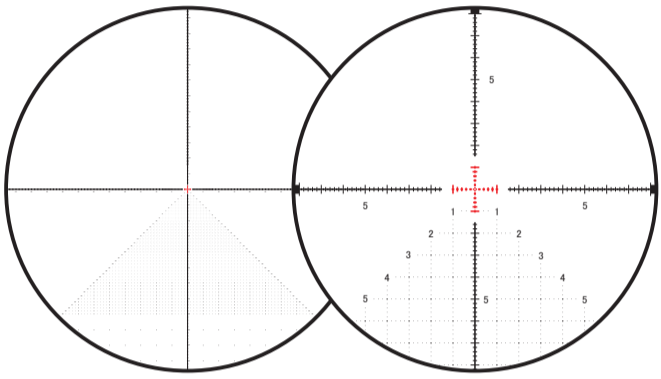

FML-T1

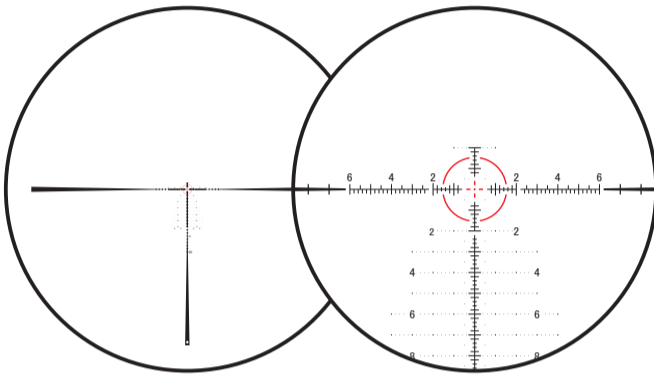

FML-TRI1

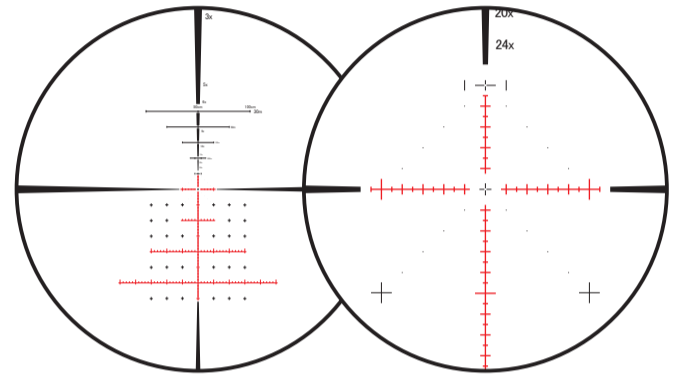

FML-MB

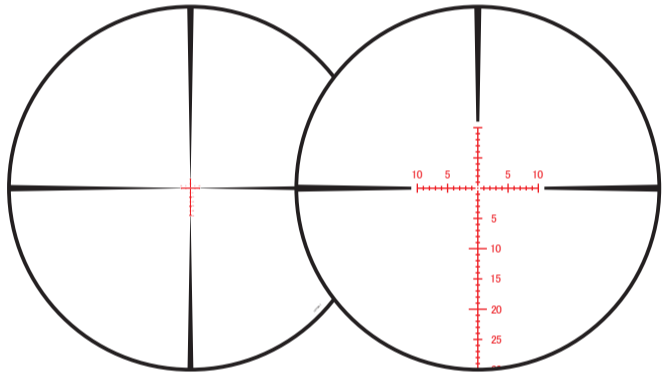

FMA-1

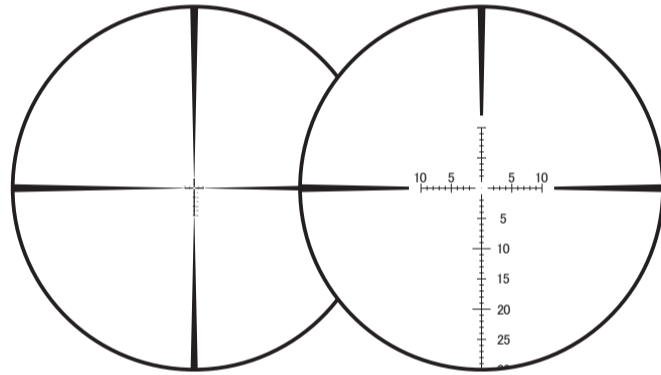

FMA-2 (Non-Illumi)

4.5-28x52

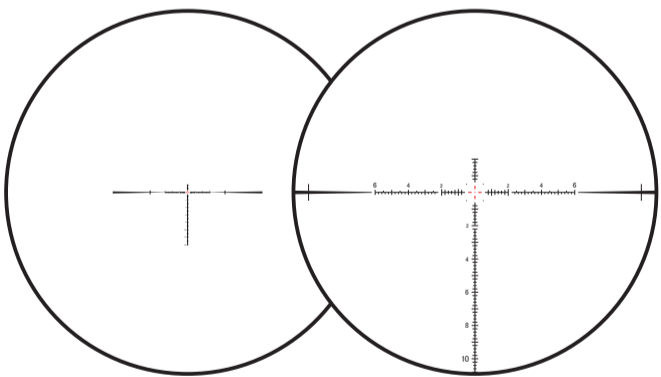

FML-3

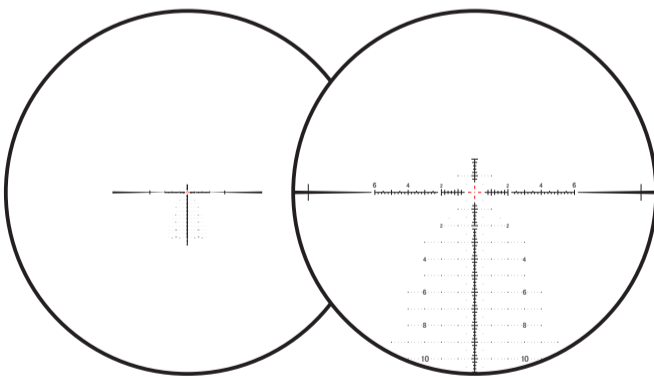

FML-TRI1

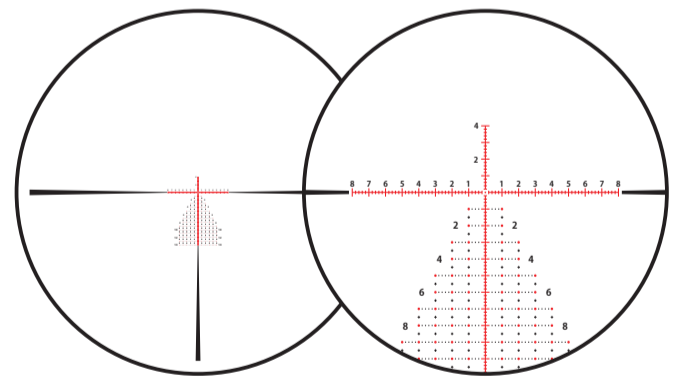

FML-PDK1

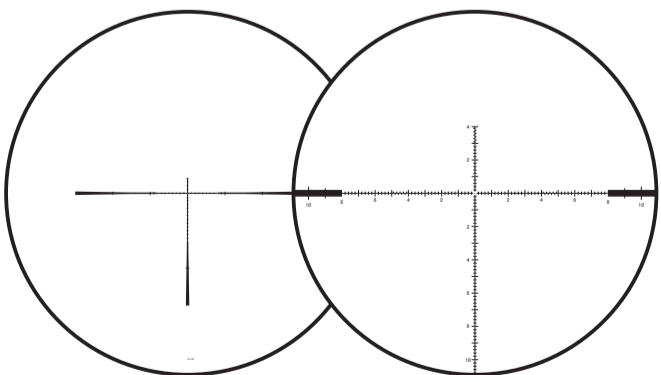

FML-LDK (Non-Illumi)

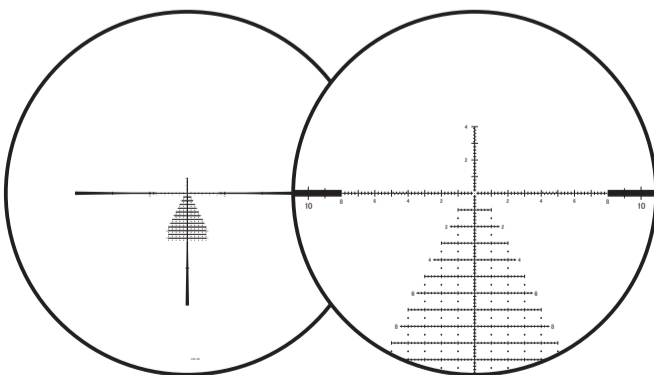

FML-PDK (Non-Illumi)

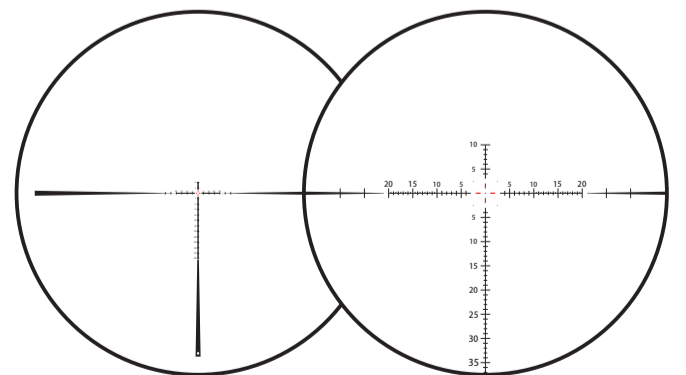

FMA-3

First Focal Plane RETICLES

Images are at the lowest power of the scope and at 30x

5-40x56 Gen II

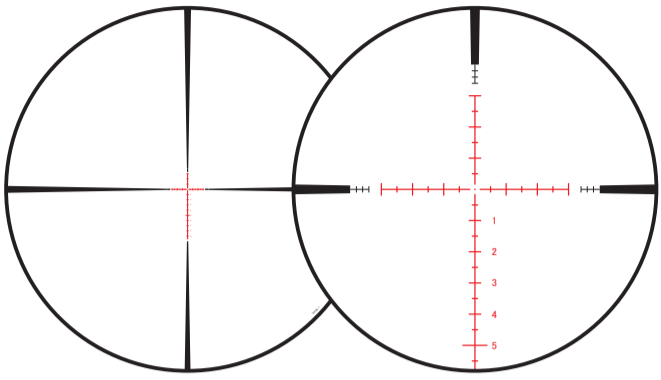

FML-1

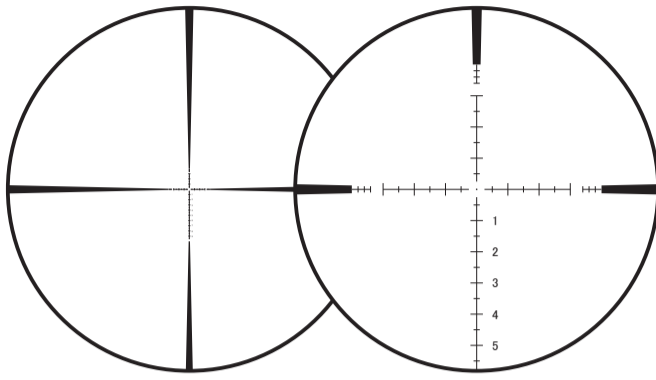

FML-1 (Non-Illumi)

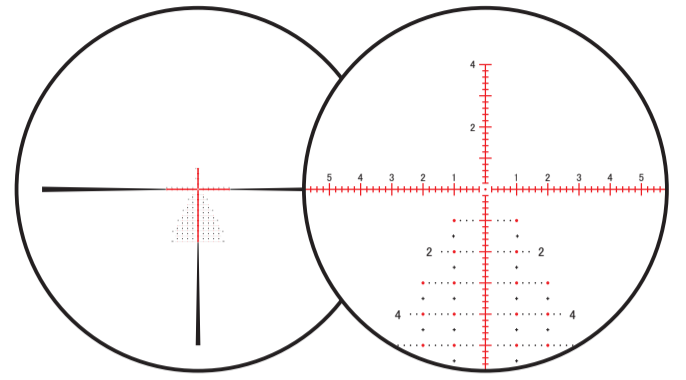

FML-PDKI

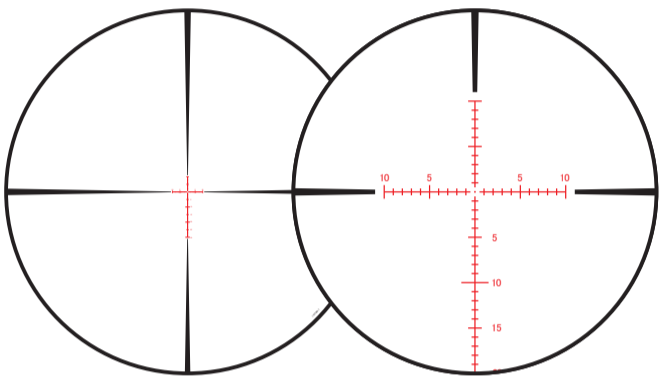

FMA-1

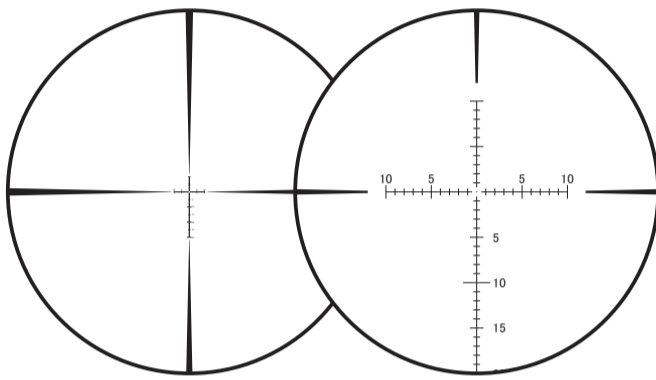

FMA-2 (Non-Illumi)

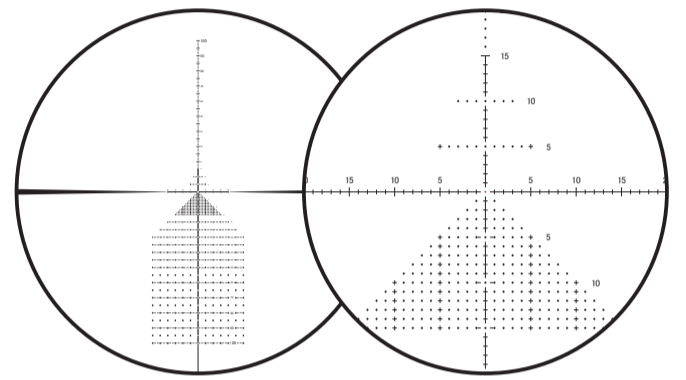

FMA-MT

5-42x56 Gen II

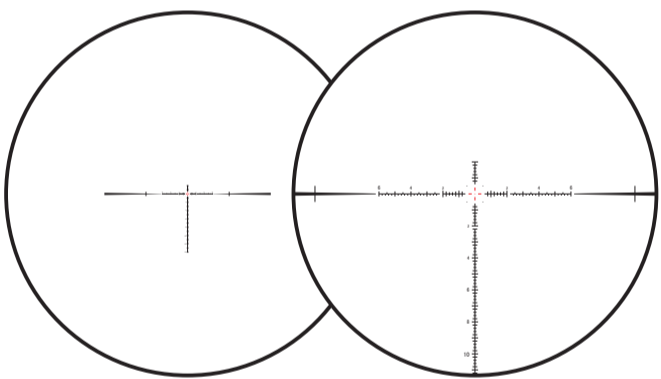

FML-3

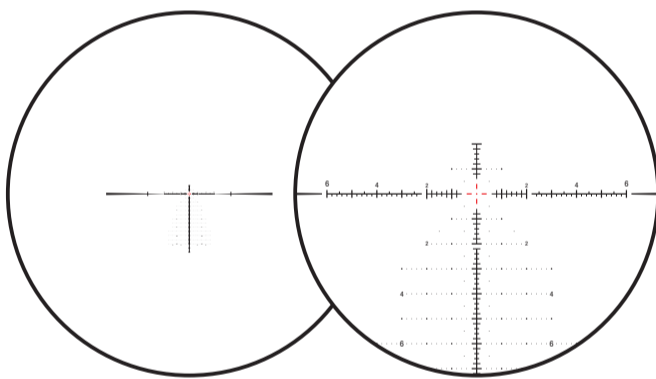

FML-TR1

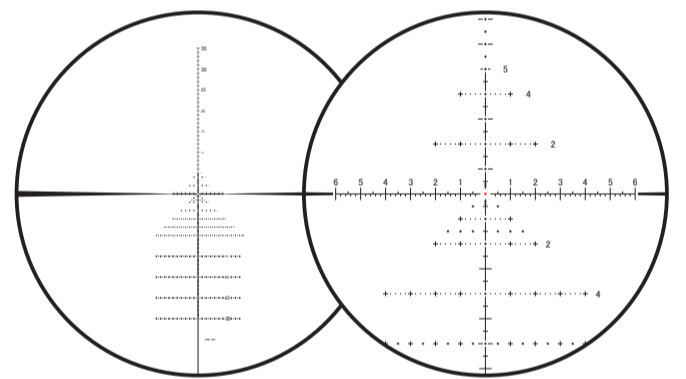

FML-MT

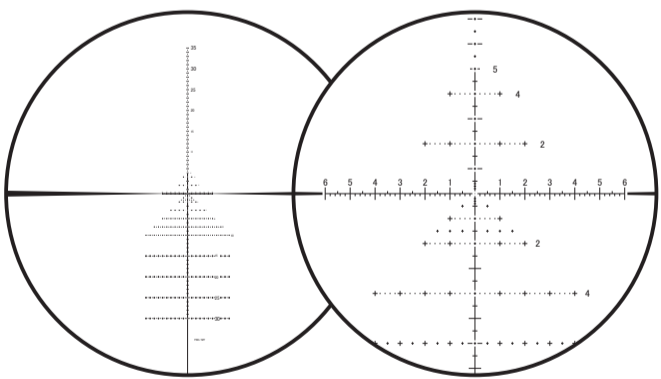

FML-MT (Non-Illumi)

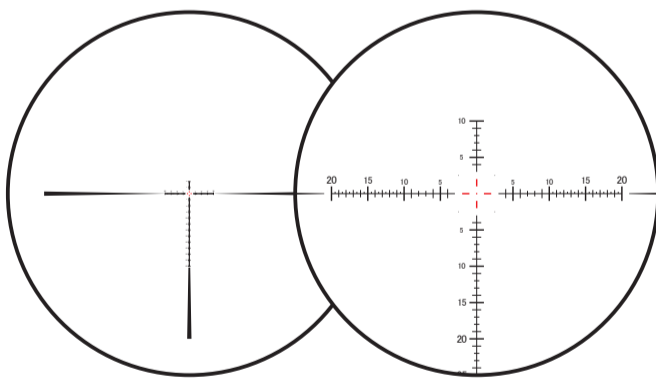

FMA-3

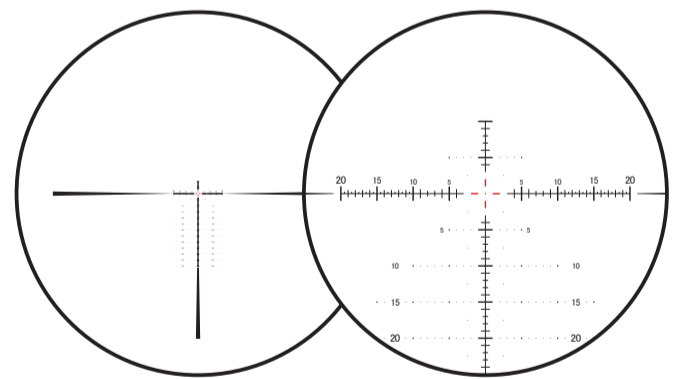

FMA-TR1

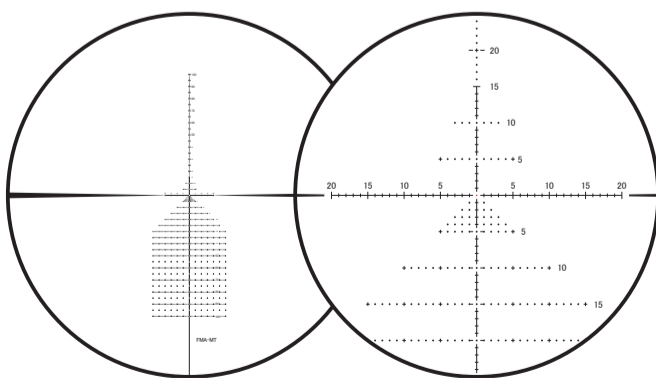

FMA-MT

First Focal Plane RETICLES

Images are at the lowest power of the scope and at 30x

4-40x52 GENESIS

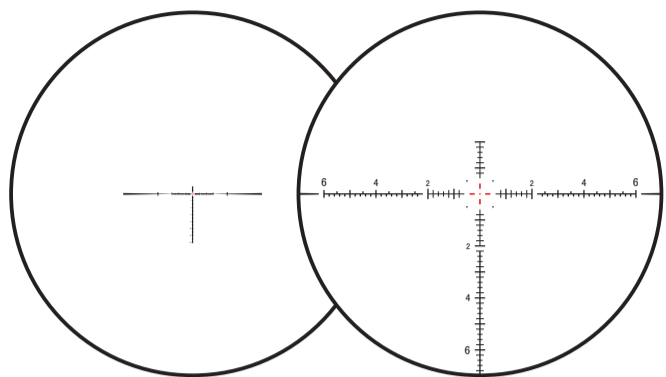

FML-3

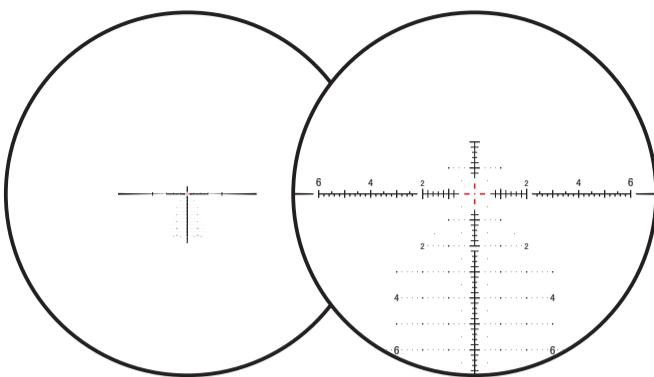

FML-TR1

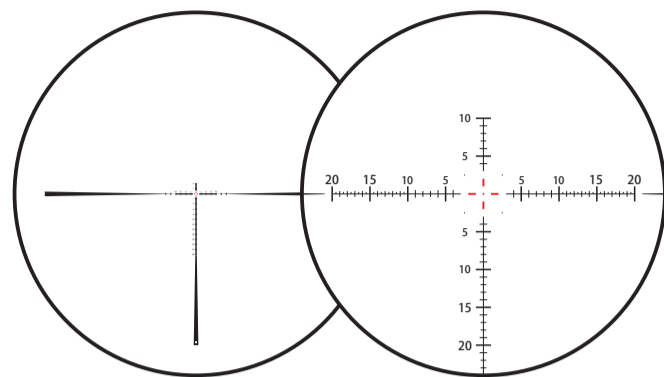

FMA-3

6-60x56 GENESIS

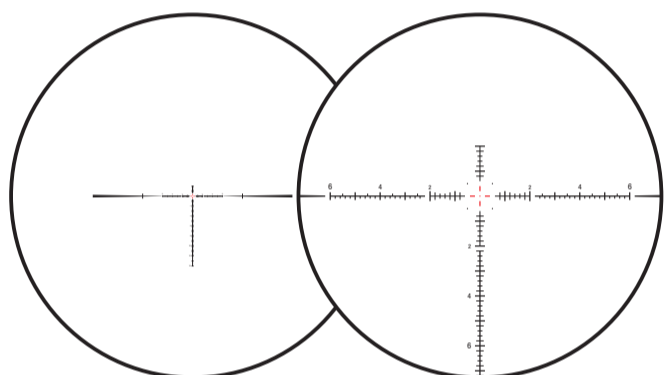

FML-3

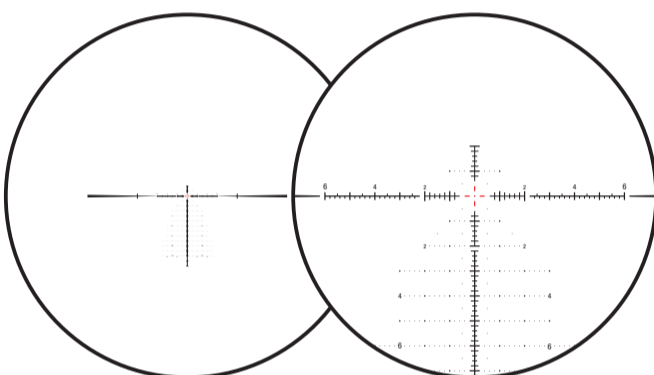

FML-TR1

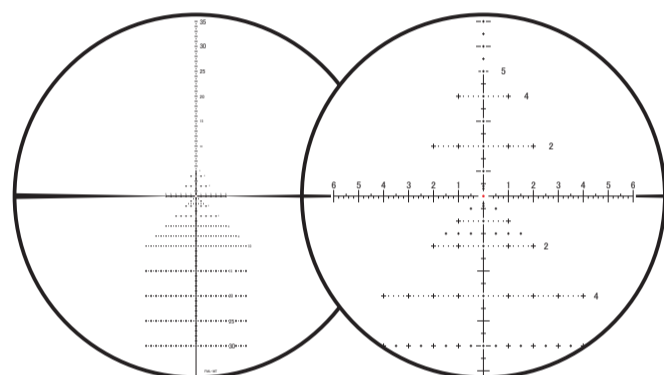

FML-MT

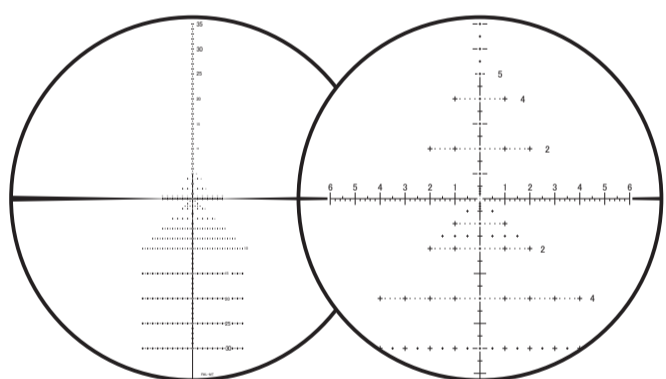

FML-MT (Non-Illumi)

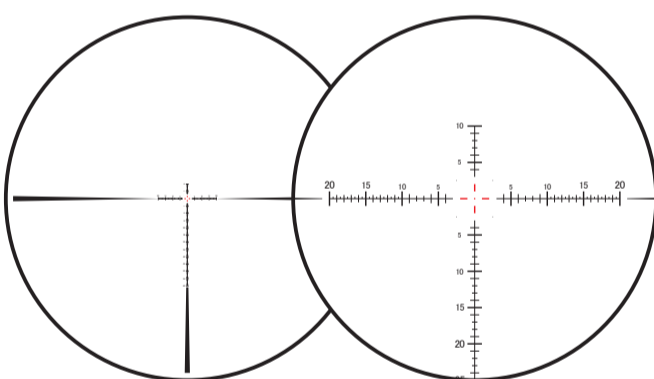

FMA-3

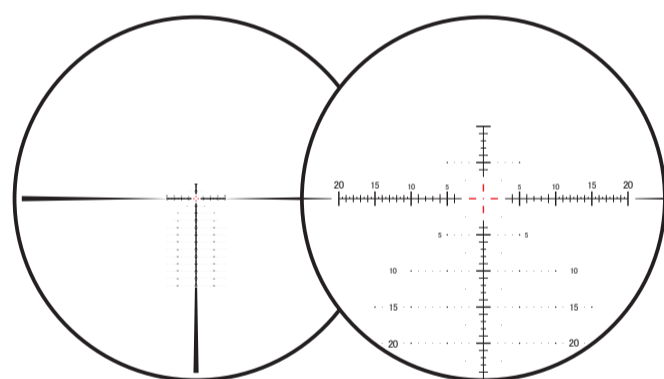

FMA-TR1

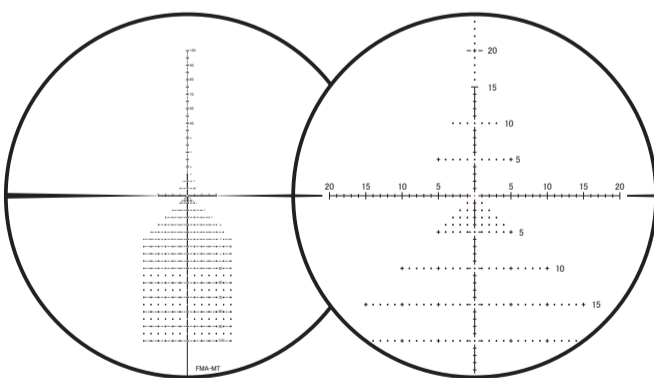

FMA-MT